



# APPVION

## *Appvion Standard Layout*

*All holes are centered on the sheet.*

*If your requirement is different, you will need to inform us.*

*See last page, number 7.*

The maximum distance from edge-of-sheet to edge-of-hole is 1/2".  
See Figure # 1, below.

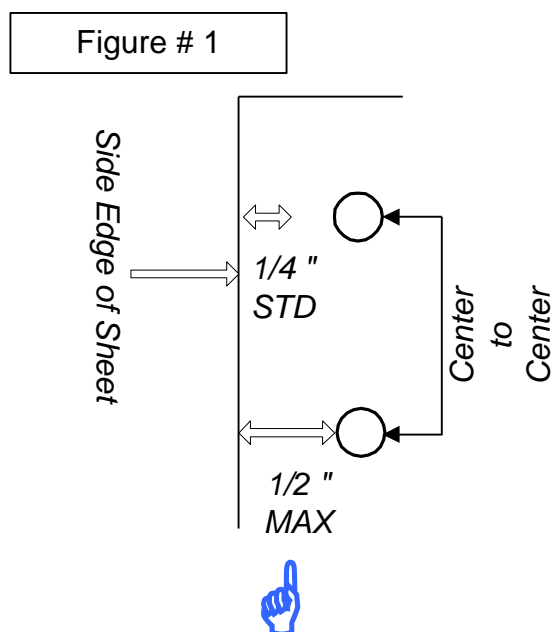

**When selecting one of Appvion's "*Standard*" Patterns, the following criteria is established:**

- 1) Diameter of holes in inches: 1/4" or 5/16"
- 2) Number of holes: 2,3,4,5 or 7
- 3) Location of holes on sheet: TOP or SIDE
- 4) Hole distance apart, center-to-center, as noted in pattern description.

***Don't find the pattern you need from the options below?***

***Please call Appvion Customer Service for additional information.  
Thank you!***

**Customer Service at 1-800-533-9421**

### **Pattern 210**

Two (2) – 1/4" diameter holes with 2 3/4" center-to-center spacing.  
1/16" min. to 1/2" max. edge-of-sheet to edge-of-hole.

Holes can be at positioned at top or side of sheet.

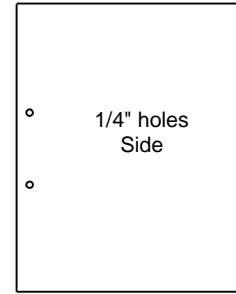
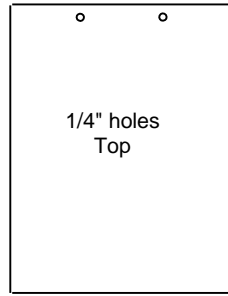

---

### **Pattern 260 - Standard**

Two (2) – 5/16" diameter holes with 2 3/4" center-to-center spacing.  
1/16" min. to 1/2" max. edge-of-sheet to edge-of-hole.

Holes can be at positioned at top or side of sheet.

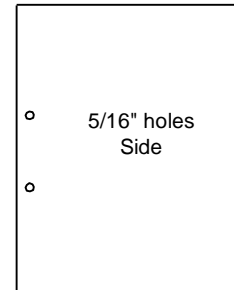
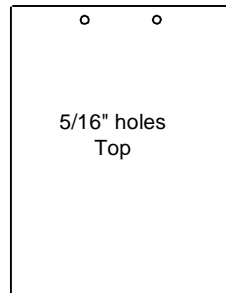

---

### **Pattern 270**

Two (2) – 5/16" diameter holes with 3 1/8" center-to-center spacing.  
1/16" min. to 1/2" max. edge-of-sheet to edge-of-hole.

Holes can be at positioned at top or side of sheet.

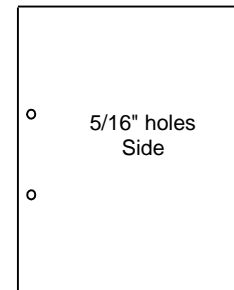
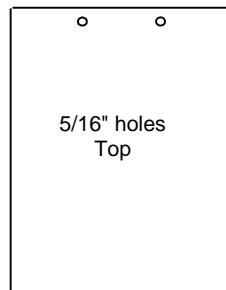

---

### **Pattern 280**

Two (2) – 5/16" diameter holes with 3 3/16" center-to-center spacing.  
1/16" min. to 1/2" max. edge-of-sheet to edge-of-hole.

Holes can be at positioned at top or side of sheet.

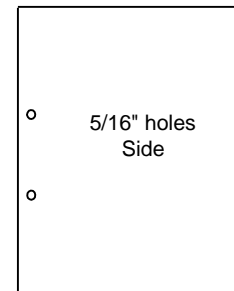
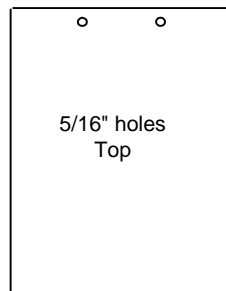

### **Pattern 310**

Three (3) – 1/4" diameter holes with  
4 1/4" center-to-center spacing.  
1/16" min. to 1/2" max. edge-of-sheet to edge-of-hole.

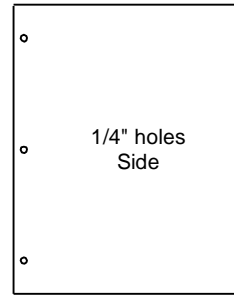

---

### **Pattern 320**

Two (2) sets of three (3) – 1/4" diameter holes with  
4 1/4" center-to-center spacing.  
1/16" min. to 3/8" max. edge-of-sheet to edge-of-hole.

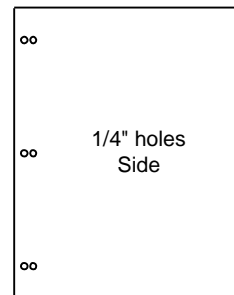

---

### **Pattern 360 - Standard**

Three (3) – 5/16" diameter holes with  
4 1/4" center-to-center spacing.  
1/16" min. to 1/2" max. edge-of-sheet to edge-of-hole.

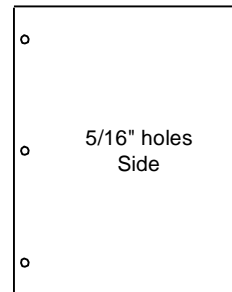

---

### **Pattern 410**

Four (4) – 1/4" diameter holes.  
3 1/8" center-to-center spacing.  
1/16" min. to 1/2" max. edge-of-sheet to edge-of-hole.

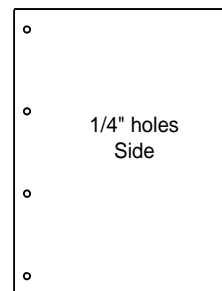

## **Pattern 460 – Standard**

Four (4) – 5/16" diameter holes with  
3 1/8" center-to-center spacing.  
1/16" min. to 1/2" max. edge-of-sheet to edge-of-hole.

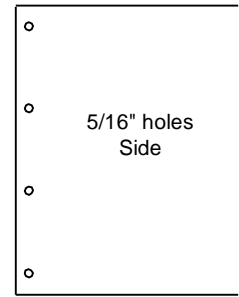

---

## **Pattern 505**

Five (5) – 1/4" diameter holes with  
1 1/8" center-to-center spacing.  
1/16" min. to 1/2" max. edge-of-sheet to  
edge-of-hole.  
Holes can be at positioned at  
top or side of sheet.

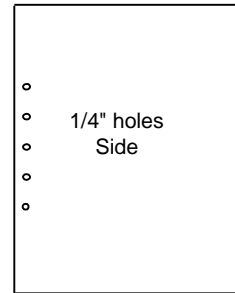
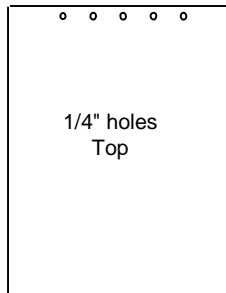

---

## **Pattern 510**

Five (5) – 1/4" diameter holes with  
1 3/8" center-to-center spacing.  
1/16" min. to 1/2" max. edge-of-sheet to  
edge-of-hole.  
Holes can be at positioned at  
top or side of sheet.

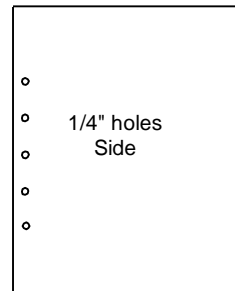
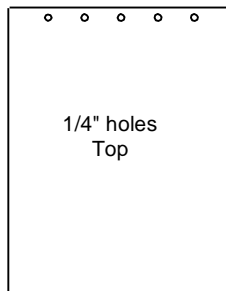

---

## **Pattern 520**

Five (5) – 1/4" diameter holes with  
1 13/32" center-to-center spacing.  
1/16" min. to 1/2" max. edge-of-sheet to  
edge-of-hole.  
Holes can be at positioned at  
top or side of sheet.

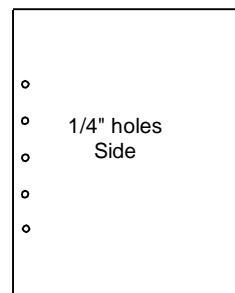
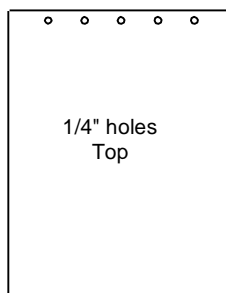

### **Pattern 570 - Standard**

Five (5) – 5/16" diameter holes with 1 3/8" center-to-center spacing. 1/16" min. to 1/2" max. edge-of-sheet to edge-of-hole.

Holes can be at positioned at top or side of sheet.

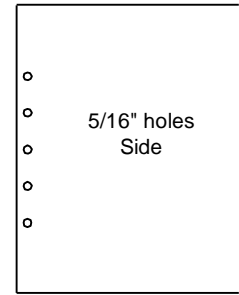
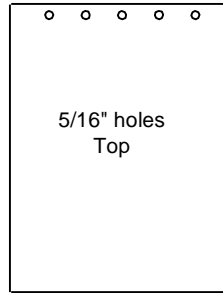

### **Pattern 580**

Five (5) – 5/16" diameter holes with 2 7/8" - 1 3/8" - 1 3/8" - 2 7/8" center-to-center spacing. 1/16" min. to 1/2" max. edge-of-sheet to edge-of-hole.

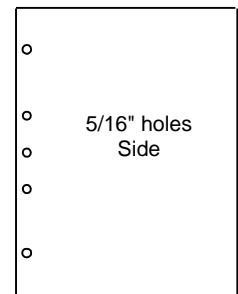

### **Pattern 710**

Seven (7) – 1/4" diameter holes with 2", 7/8", 1 3/8", 1 3/8", 7/8" and 2" center-to-center spacing. 1/16" min. to 1/2" max. edge-of-sheet to edge-of-hole.

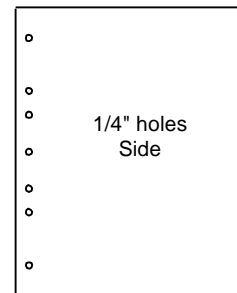

### **Pattern 760 - Standard**

Seven (7) – 5/16" diameter holes with center-to-center spacing 2", 7/8", 1 3/8", 1 3/8", 7/8" and 2". 1/16" min. to 1/2" max edge-of-sheet to edge-of-hole.

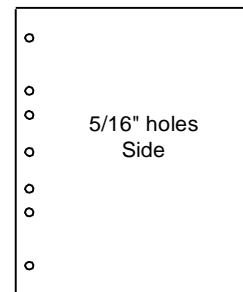

# Customer Hole Punch Instruction Sheet

- Lay your sheet on a table with holes facing away from you (See Figure # 2, below.).
- Number the holes starting with one (1) at the far left side of the sheet.

## Appvion needs the following measurement information from you:

1. Diameter of the holes, in inches, on your sheet? \_\_\_\_\_
2. How many holes are there on your sheet? \_\_\_\_\_
3. What is the measurement, in inches, of your sheet along the hole side? \_\_\_\_\_
4. What is the measurement, in inches, of your sheet on the other side (where there are no holes)? \_\_\_\_\_
5. What is the measurement, in inches, between the holes? \_\_\_\_\_
6. What is the measurement, in inches, between the edge of your sheet and the edge of the holes? \_\_\_\_\_
7. **Holes are centered on the sheet** unless you advise otherwise.

If you **do not want** the holes centered on the sheet:

- a) Measure the distance from the top edge of the sheet, to the top edge of the hole, farthest to the right.  
What is that measurement, in inches? \_\_\_\_\_
- b) Measure the distance from the bottom edge of the sheet, to the bottom edge of the hole, farthest to the left.  
What is that measurement, in inches? \_\_\_\_\_

